

CHT-4A MV Series Dual In Line Package mV Output, Temperature Compensated Voltage Supply

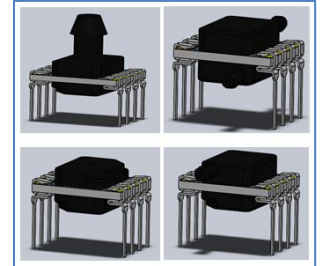

DESCRIPTION

Advanced Sensor Ceramic Hybrid Technology (CHT) 4A MV Series is a temperature compensated, mV output, PCB mounted pressure sensor packaged in a rugged Dual In Line package. The Ceramic Hybrid Technology uses a silicon MEMS pressure sensor bound to a ceramic substrate containing thick film resistors that are uniquely laser trimmed for each sensor. Incorporating a flexible design, the CHT-4AMV Series is available with side port, top ports or manifold mounted ports and can be mounted with SMT pin, Dual in line pin or in line pin to allow OEMs to optimize their board design. The CHT-4A MV series is powered using constant voltage, the tight span control will ensure sensor field interchangeability.

CHT-4A MV series superior die performance, coupled with rugged ceramic substrate ensures long term stability with superior temperature performance over wide operating range.

APPLICATIONS

- Pneumatic controls
- Automotive diagnostics
- Medical equipment/instrumentation
- Air Speed and Altitude
- Environmental controls
- Barometric pressure measurement
- Factory Automation
- Process Controls

FEATURES

- Field Interchangeability
- Constant Voltage
- Wide selection of port
- Two Piece Ports for Liquid Measurements
- Absolute, Differential or Gage pressures
- Temperature Compensated
- 0.5% Pressure Non Linearity (Typical)

SPECIFICATIONS

	Symbol	Min	Typical	Max	Unit	Note
Performance Characteristic						
Supply Voltage		0.5	10	16	Vdc	
Bridge Resistance, Input & Output		1500		12000	Ω	
Zero Pressure Offset		-1.5	±0.5	+1.5	mV	
Pressure Non Linearity		-0.5		+0.5	%FSS	2
Hysteresis & Repeatability			0.05		%FSS	
Full Scale Span	FSS	79	80	81	mV	3
Temperature Hysteresis, Offset & Span		-0.20		+0.20	%FSS	4
Thermal Error of Span		-0.5		+0.5	%FSS	
Thermal Error of Offset		-0.5		+0.5	%FSS	
Response Time			100		μS	
Insulation Resistance		50			M Ω	
Long Term Stability, Offset & Span			±0.4		%FSS	5
Weight				3	grams	
Compensated Temperature			0 to 50		°C	
Operating Temperatures			-40 to 125		°C	

SPECIFICATIONS	Symbol	Min	Typical	Max	Unit	Note
Absolute Maximum Conditions						7
Supply Voltage				16	Vdc	
Storage Temperature		-50		150	°C	
Overage Pressure						
Burst, Gauge, Differential Pressure				3x	Range	6
Burst , Absolute Pressure				10x	Range	6
Media Compatibility		CDA, Non Ionic, Non Corrosive Gases				
Wetted Materials		Ceramic, Epoxy, RTV, Silicon, Gold, Aluminum, Palladium Silver PPS (Top Barb Port)				

Reference Conditions: Vsupply: 10Vdc, Ta=25 °C. Positive Pressure Applied to Port A

1. All specification at reference conditions unless otherwise noted. Output is ratio metric to supply voltage.
2. ½ Terminal Base Non Linearity (Measured at 0, 50% and 100% FS).
3. Full Scale Span output with sensor only. Span is 50mV for products less than 5Kpa pressure range.
4. Deviation between 50 °C and 0 °C expressed as percentage of reading at 25 °C.
5. Deviation after 1 year period measured at reference conditions.
6. Maximum overpressure value is limited to 200psi for any configuration.
7. Exceeding Absolute Maximum Specification may damage the device. Extended exposure beyond the operating conditions may affect device reliability.

MECHANICAL DIMENSIONS in [mm]

DUAL IN LINE, THRU HOLE

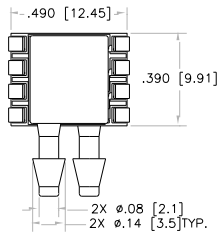

HORIZONTAL BARB, DUAL

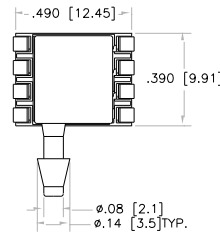

HORIZONTAL BARB, TOP

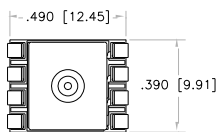
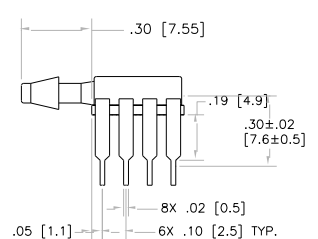
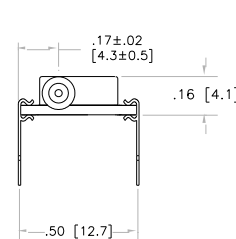
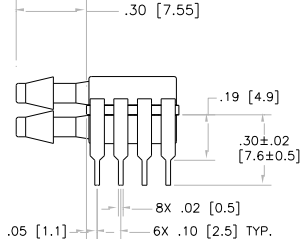
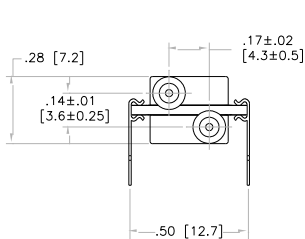

VERTICAL BARB, TOP

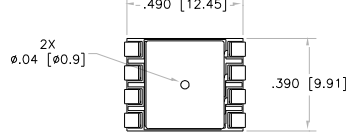

VERTICAL HOLE, DUAL

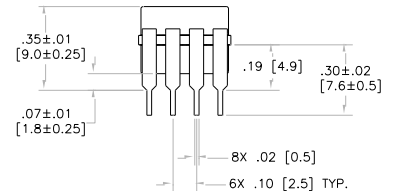
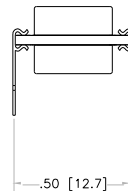
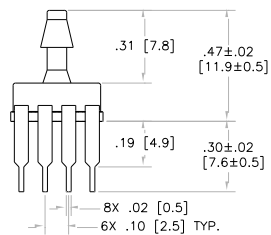
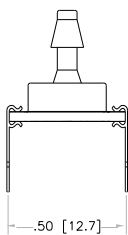

DUAL IN LINE, J LEAD SMT

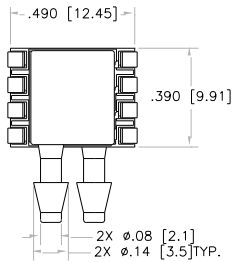

HORIZONTAL BARB, DUAL

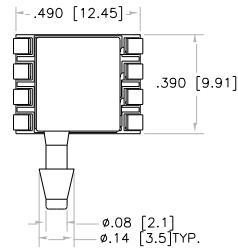

HORIZONTAL BARB, TOP

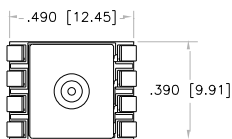
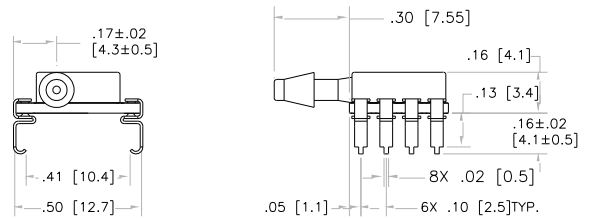
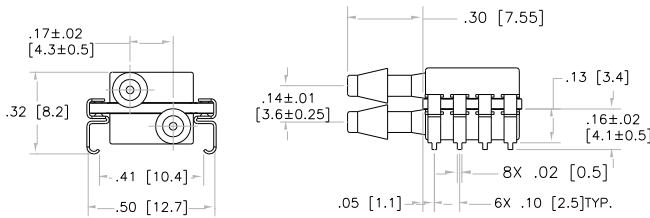

VERTICAL BARB, TOP

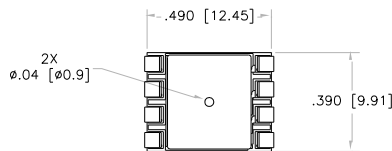

VERTICAL HOLE, DUAL

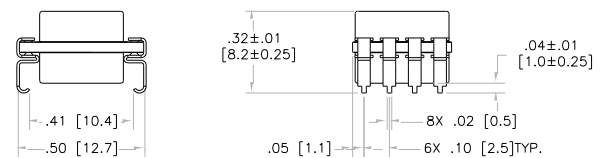
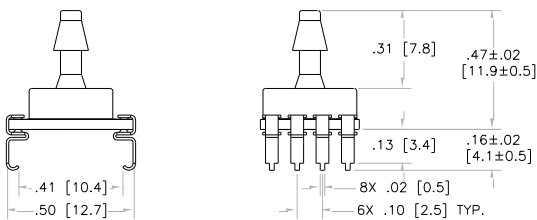

DUAL IN LINE, J LEAD SMT

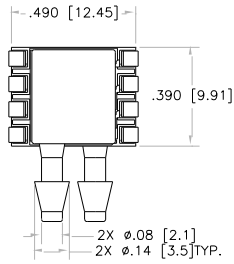

HORIZONTAL BARB, DUAL

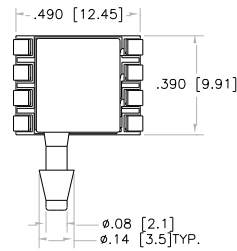

HORIZONTAL BARB, TOP

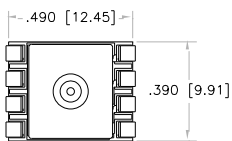
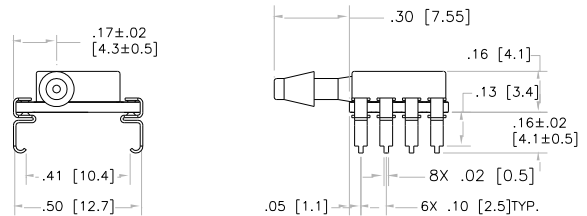
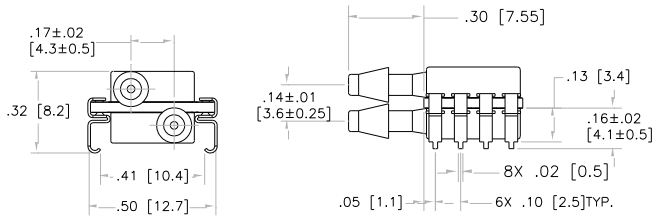

VERTICAL BARB, TOP

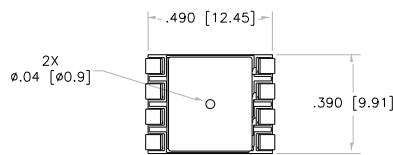

VERTICAL HOLE, DUAL

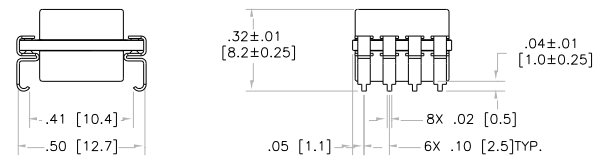
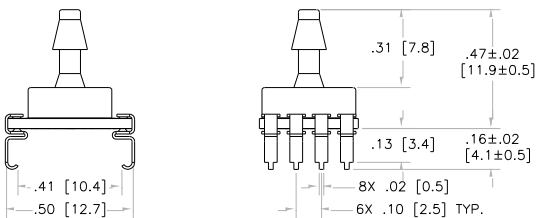

SINGLE IN LINE, S & SL LEAD

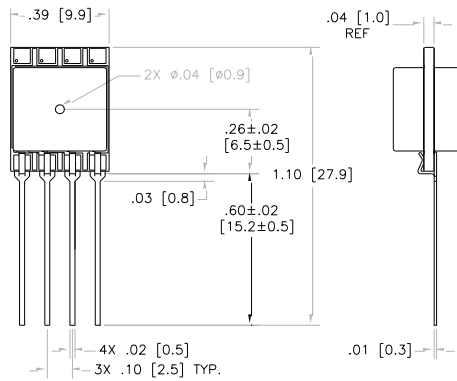
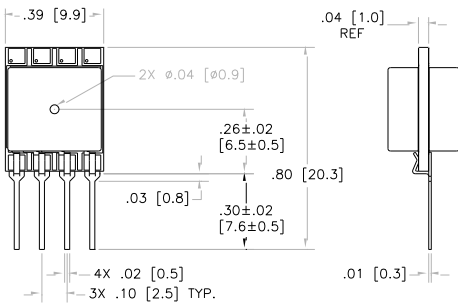
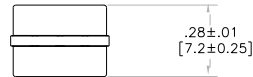
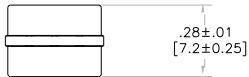

VERTICAL HOLE, DUAL
S PIN STYLE

VERTICAL HOLE, DUAL
SL PIN STYLE

PORT DESIGNATION

HORIZONTAL BARB, DUAL

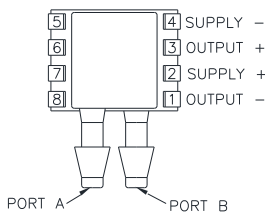

HORIZONTAL BARB, TOP

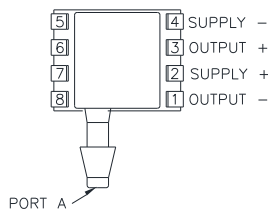

VERTICAL BARB, TOP

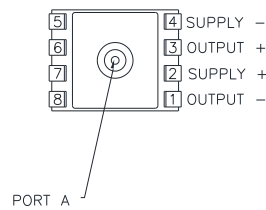

VERTICAL HOLE, DUAL

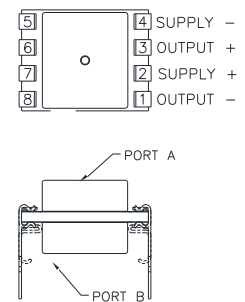

PART NUMBERING FOR ORDERS

Series	Port Type	Package	Pressure Range	Pressure Units	Pressure Type (Range Availability) [Package Availability]	Options
CHT-4A MV	VHD=Vertical Hole, Dual	J= J lead SMT	002 008	M=mBar	G= Gage (All Ranges) [All Port Types]	GC= Gel Coat GF = Gel Fill GF Option utilize a two piece port configuration and potted gel fill for liquid level measurements.
	HBD=Horizontal Barb, Dual	T= DIL Thru Hole	005 015 030 050 100 150	P=PSI	A=Absolute (15 PSI Range & above, 1 Bar Ranges & above) [All Port Types]	
	VBT=Vertical Barb, Top	S=SIL				
	HBO=Horizontal Barb, Opposing	SL= SIL Long				
	HBT=Horizontal Barb, Top					
			001 002 006	B=Bar		
			004 020	I=inH2O		

Part Number Example: CHT-4AMV VBTJ005PG51

Vertical Barbed Top Port, J Leaded SMT Package, 0 to +5 PSI Range, 5.0Vdc Supply, Pmin=0 PSIG, Pmax=+ 5 PSIG

WARRANTY

Pressure sensors have a limited one-year warranty to the original purchaser. AVSensors will repair or replace, at its option, without charge those items it finds defective. This is the buyers sole remedy and is in lieu of all other warranties, expressed or implied, including those of merchantability and fitness for a particular purpose. In no event shall AVSensors be liable for consequential, special, or indirect damages. This warranty does not apply to units that have been modified, misused, neglected or installed where the application exceeds published ratings. Specifications may change without notice. The information supplied is believed to be accurate and reliable as of this printing, however, we assume no responsibility for its use.