

6

### The MCT-4A Series

Dual & Single In Line Package (SIL & DIL)

High Level Analog Output

3.3 & 5.0 Vdc Supply Voltages

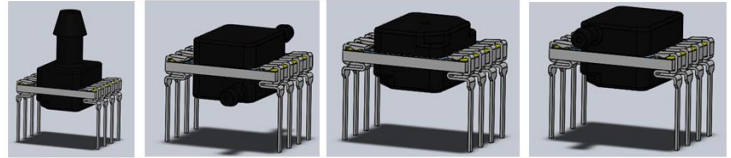

#### DESCRIPTION

Advanced Sensors Multi Chip Technology (MCT) 4A Series incorporates the latest mixed signal ASIC (Application Specific Integrated Circuit) with a bonded silicon gage to provide a high level analog output for medical, life science and pneumatic control industries. The designs superior performance provides 1% Total Error across a wide temperature range of -10 to 85 °C. The ASIC's advanced design allows for the sensor output to be limited for safety critical operations with internal error checking of the sensor's input and output lines. With all the advanced features, the MCT-4A series is the ideal choice for OEM customers.

#### APPLICATIONS

- Pneumatic controls
- Automotive diagnostics
- Medical equipment/instrumentation
- Air Speed and Altitude
- Environmental controls
- Barometric pressure measurement
- Factory Automation
- Process Controls

#### FEATURES

- Ratiometric, Analog Voltage Output
- Low Power Option
- 3.3 & 5.0Vdc Supply Voltages
- Low Overall Errors, 1%TEB
- Many Port Configurations
- Custom Outputs and Ranges Available

#### SPECIFICATIONS

|   | Symbol | Min   | Typical    | Max  | Unit  | Note |
|---|--------|-------|------------|------|-------|------|
| <b>Performance Specifications</b>         |        |       |            |      |       |      |
| Supply Voltage                            |        | 2.7V  | 3.3        | 5.50 | V     |      |
| Current Consumption                       |        |       |            | 3    | mA    |      |
| Current Consumption, -L Option            |        |       | 0.25       |      | mA    |      |
| Pressure Accuracy                         |        | -0.25 |            | 0.25 | mA    | 2    |
| Total Error Band, 5inH20 and above        | TEB    | -1.00 |            | 1.00 | %FSS  | 3    |
| Total Error Band, Below 5inH20 to 10mBar  | TEB    | -1.50 |            | 1.50 | %FSS  | 3    |
| Total Error Band, Below 10mBar to 6mBar   | TEB    | -2.00 |            | 2.00 | %FSS  | 3    |
| Total Error Band, Below 6mBar to 1.25mBar | TEB    | -3.00 |            | 3.00 | %FSS  | 3    |
| Output DAC Resolution                     |        |       |            | 12   | bits  |      |
| Output (Type 1) at Pmin                   |        |       | 10         |      | %Vdd  |      |
| Output (Type 1) at Pmax                   |        |       | 90         |      | %Vdd  |      |
| Output (Type 2) at Pmin                   |        |       | 5          |      | %Vdd  |      |
| Output (Type 2) at Pmax                   |        |       | 95         |      | %Vdd  |      |
| Conversion Time                           |        |       | 1.0        |      | mS    | 4    |
| Power On to Valid Data                    |        |       |            | <10  | mS    | 5    |
| Weight                                    |        |       |            | 3    | grams |      |
| Compensated Temperature                   |        |       | -10 to 85  |      | °C    | 6    |
| Operating Temperature                     |        |       | -40 to 125 |      | °C    | 6    |

| SPECIFICATIONS                     | Symbol | Min   | Typical | Max | Unit | Note      |
|------------------------------------|--------|---|---------|-----|------|-----------|
| <b>Absolute Maximum Conditions</b> |        |   |         |     |      | <b>10</b> |
| Supply Voltage                     |        | -5.0  |         | 6   | V    |           |
| Storage Temperature                |        | -40   |         | 125 | °C   | 6         |
| Package Integrity, Common Mode     |        |   |         | 300 | psi  | 7         |
| Proof Pressure                     |        |   |         | 3x  |      | 8         |
| Burst Pressure                     |        |   |         | 5x  |      | 9         |
| Media Compatibility                |        | CDA, Non Ionic, Non Corrosive Gases               |         |     |      |           |
| Wetted Materials                   |        | Ceramic, RTV, Epoxy, Silicon, Gold, Aluminum, LCP |         |     |      |           |

**Reference Conditions:** Vsupply: 3.30Vdc or 5.00, Ta=25 °C, Positive Pressure Port A

1. All specification at reference conditions unless otherwise noted.
2. Maximum deviation from a Best Fit Straight Line through Pmin and Pmax measured at 25 °C. Errors included Pressure Non Linearity, Pressure Hysteresis and Repeatability.
3. Maximum deviation from the Ideal Transfer Function expressed as a percentage of the %FSS over the compensated temperature range. Includes calibration errors (Offset & Span), temperature errors (Offset & Span), pressure non-linearity, pressure and thermal hysteresis.
4. The time for the output DAC to be updated with new data.
5. The time for the output DAC to have valid data after a power on reset.
6. Compensated, operating and storage temperatures for mBar/inH2O ranges are 0 °C to 60 °C, -10 °C to 85 °C, and -20 °C to 105 °C respectively
7. Maximum pressure the sensor package can withstand without rupture.
8. Maximum pressure without degrading sensor's performance specifications.
9. Maximum pressure the silicon diaphragm can withstand without rupture.
10. Exceeding Absolute Maximum Specification may damage the device. Extended exposure beyond the operating conditions may affect device reliability.
11. Enabled Diagnostic option will clip the output voltage at 5% and 95% of supply voltage. Output will remain within 2.5% of the supply rails when the diagnostic is triggered.
12. Switch Port option will change the Positive Pressure Port to B on dual pressure port configurations (VHD, HBD).
13. Potted Gel option will use a two piece port design having the same dimensions and made from the same material.

### PRESSURE TRANSFER FUNCTIONS

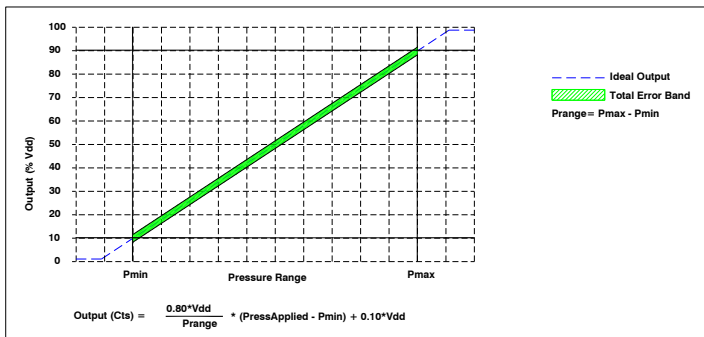

Type 1, 10-90%, Pressure Transfer Function

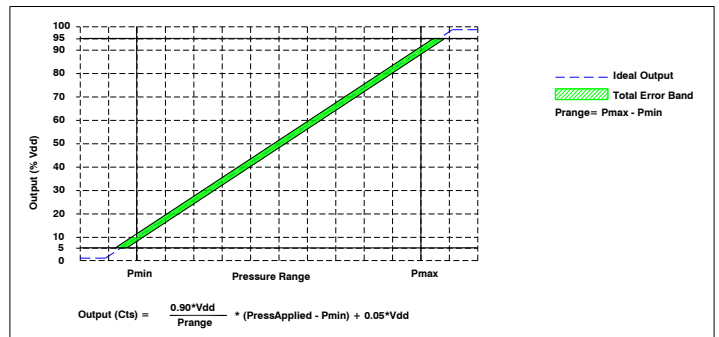

Type 2, 5-95%, Pressure Transfer Function

### MECHANICAL DIMENSIONS in [mm]

## DUAL IN LINE, THRU HOLE

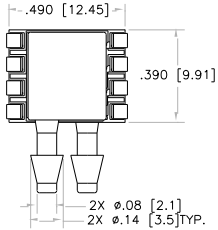

HORIZONTAL BARB, DUAL

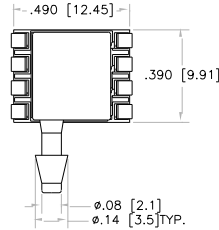

HORIZONTAL BARB, TOP

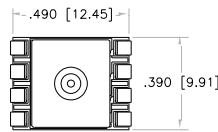
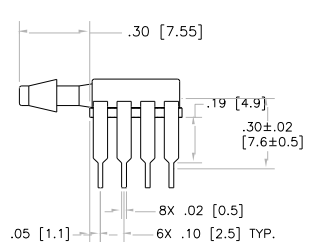
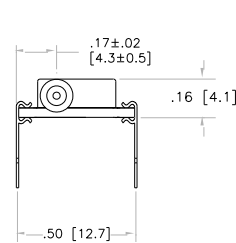
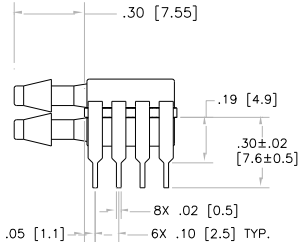
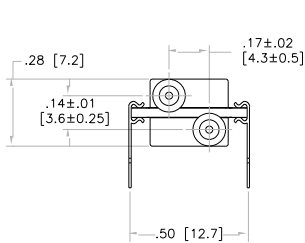

VERTICAL BARB, TOP

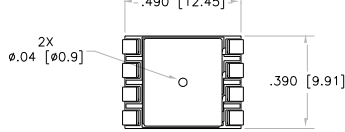

VERTICAL HOLE, DUAL

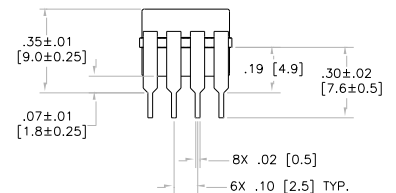
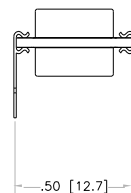
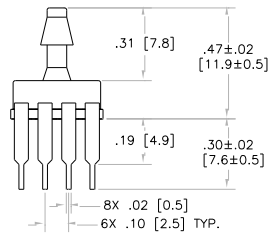
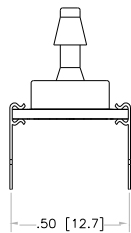

# DUAL IN LINE, J LEAD SMT

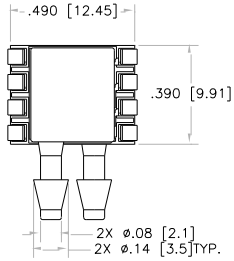

**HORIZONTAL BARB, DUAL**

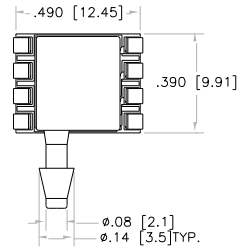

**HORIZONTAL BARB, TOP**

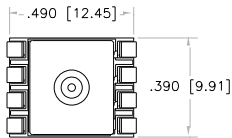
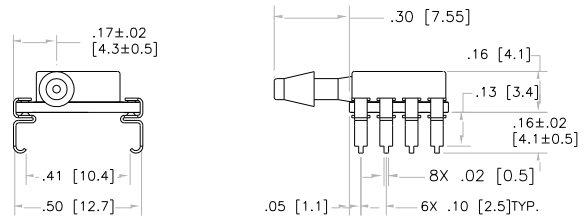
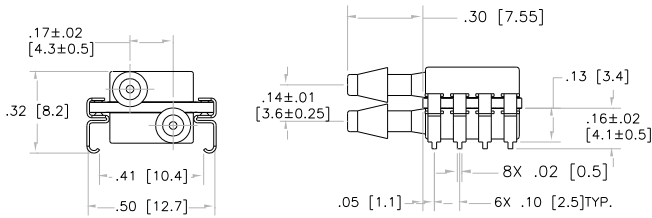

**VERTICAL BARB, TOP**

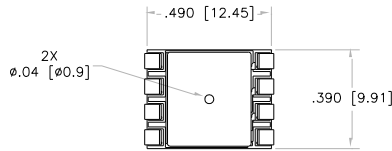

**VERTICAL HOLE, DUAL**

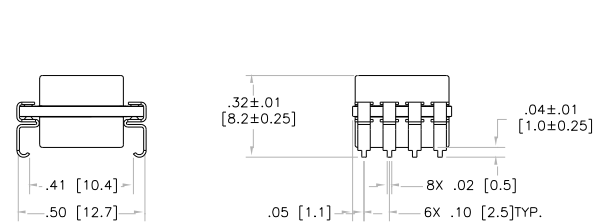
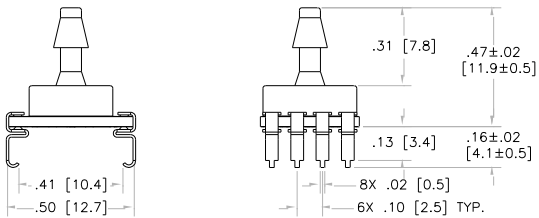

# SINGLE IN LINE, S & SL LEAD

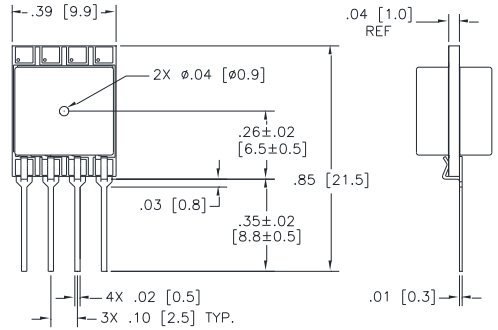
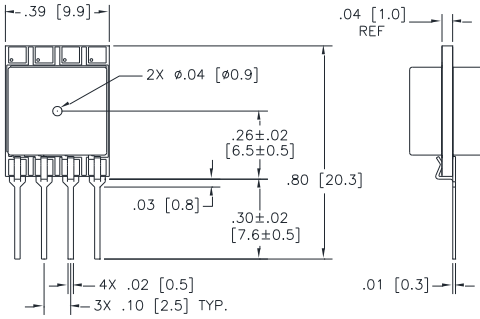
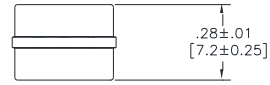
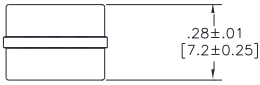

VERTICAL HOLE, DUAL  
S PIN STYLE

VERTICAL HOLE, DUAL  
SL PIN STYLE

### PORT DESIGNATION

HORIZONTAL BARB, DUAL

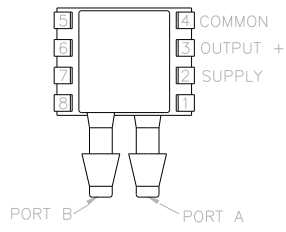

HORIZONTAL BARB, TOP

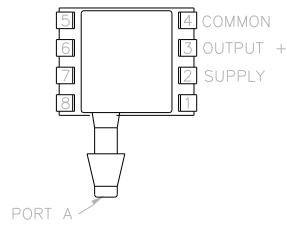

VERTICAL BARB, TOP

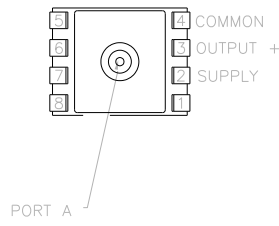

VERTICAL HOLE, DUAL

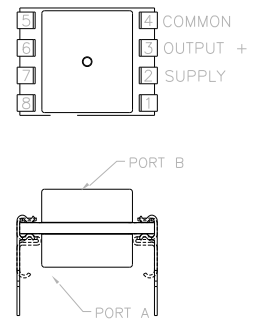

VERTICAL HOLE, DUAL,  
S/SL PIN STYLE

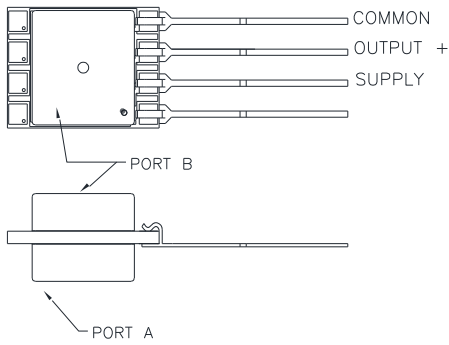

### PART NUMBERING FOR ORDERS

| Series | Port Type                     | Package          | Pressure Range                         | Pressure Units | Pressure Type (Range Availability) [Package Availability]                | Calibrated Voltage   | Output Type   | Options  |
|--------|-------------------------------|------------------|--|----------------|--|----------------------|---|--|
| MCT-4A | VHD=Vertical Hole, Dual       | J= J lead SMT    | 005<br>010<br>020                      | M=mBar         | G= Gage (All Ranges) [All Port Types]                                    | 3=3.3Vdc<br>5=5.0Vdc | Type1= 10 -90% of Supply Voltage<br>Type2= 5 -95% of Supply Voltage | -L Low Power<br><br>-DE Diagnostics Enabled (See Note 11)<br><br>-SP Switched Port (See Note 12)<br><br>-PG Potted Gel (See Note 13) |
|        | HBD=Horizontal Barb, Dual     | T= DIL Thru Hole | 050<br>100<br>200                      |                | A=Absolute (15 PSI Range & above, 1 Bar Ranges & above) [All Port Types] |                      |   |  |
|        | VBT=Vertical Barb, Top        | S=SIL            | 001<br>002                             | P=PSI          |  |                      |   |  |
|        | HBO=Horizontal Barb, Opposing | SL= SIL Long     | 005<br>015<br>030<br>050<br>100<br>150 |                | B=Bidirectional (All Ranges) [All Port Types]                            |                      |   |  |
|        | HBT=Horizontal Barb, Top      |                  | 001<br>002<br>003<br>006               | B=Bar          |  |                      |   |  |
|        |                               |                  | 0.5<br>001<br>002<br>004               | I=inH2O        |  |                      |   |  |

Part Number Example: **MCT-4A VBTJ005PG51**

**Vertical Barbed Top Port, J Leaded SMT Package, 0 to +5 PSI Range, 5.0Vdc Supply, Pmin=0 PSIG, Pmax=+ 5 PSIG**

### WARRANTY

Pressure sensors have a limited one-year warranty to the original purchaser. AVSensors will repair or replace, at its option, without charge those items it finds defective. This is the buyers sole remedy and is in lieu of all other warranties, expressed or implied, including those of merchantability and fitness for a particular purpose. In no event shall AVSensors be liable for consequential, special, or indirect damages. This warranty does not apply to units that have been modified, misused, neglected or installed where the application exceeds published ratings. Specifications may change without notice. The information supplied is believed to be accurate and reliable as of this printing, however, we assume no responsibility for its use.