

The MCT-24DHRD Series
Dual & Single In Line Package (SIL & DIL)
Digital Temperature & Pressure Outputs
I²C & SPI Protocols

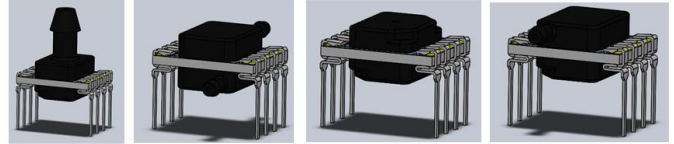

DESCRIPTION

Advanced Sensors Multi Chip Technology (MCT) 24DHRD Series incorporates a bonded silicon gage to the latest mixed signal ASIC (Application Specific Integrated Circuit) with a leading **24Bit** High Resolution ADC ($\Sigma \Delta$) specifically designed for medical, life science and avionic control industries. The MCT 24DHRD Series provides a 24bit digital pressure and 16 bit digital temperature output in SPI and I²C protocols. The advanced design requires **no** external calculation since a fully integrated digital signal processor (DSP) performs an error correction algorithm. The designs superior performance provides 1% Total Error across a wide temperature range of -10 to 85° Given these features and an advanced low power design; the MCT-24DHRD series is the ideal choice for OEM customers.

APPLICATIONS

- Avionic Instrumentation
- Automotive diagnostics
- Medical equipment/instrumentation
- Air Speed and Altitude
- Environmental controls
- Barometric pressure measurement
- Factory Automation
- Process Controls

FEATURES

- Internal Error Correction
- Low Power Sleep Stage
- Highly Accuracy
- Wide Supply Voltage
- High Resolution Digital Output (24bit Pressure, 16bit Temperature)
- I²C & SPI Outputs
- Custom Outputs and Ranges Available

SPECIFICATIONS

	Symbol	Min	Typical	Max	Unit	Note
Performance Specifications						
Supply Voltage		1.8	3.3	5.50	V	
Current Consumption				3	mA	
Standby Current			0.2		µA	
Pressure Resolution				24	bits	
Temperature Resolution				16	bits	
Output (Type 1) at Pmin			-6710886		cts	
Output (Type 1) at Pmax			+6710886		cts	
Output (Type 2) at Pmin			-7549747		cts	
Output (Type 2) at Pmax			+7549747		cts	
Pressure Accuracy		-0.5		0.5	mA	2
Total Error Band	TEB	-1.0		1.0	%FSS	3
Temperature Accuracy			1.5		°C	
Long Term Stability			±0.4		%FSS	
Conversion Time			1.0		mS	4
Power On to Valid Data				<10	mS	5
Weight				3	grams	
Compensated Temperature			-10 to 85		°C	6
Operating Temperature			-40 to 125		°C	6

SPECIFICATIONS	Symbol	Min	Typical	Max	Unit	Note
Absolute Maximum Conditions						10
Supply Voltage		-		6.5	V	
Storage Temperature		-50		150	°C	
Package Integrity, Common Mode				300	psi	7
Proof Pressure				3x		8
Burst Pressure				5x		9
Media Compatibility		CDA, Non Ionic, Non Corrosive Gases				
Wetted Materials		Ceramic, RTV, Epoxy, Silicon, Gold, Aluminum, LCP				

Reference Conditions: Vsupply: 3.30Vdc Ta=25 °C, Positive Pressure Port A

1. All specification at reference conditions unless otherwise noted.
2. Maximum deviation from a Best Fit Straight Line through Pmin and Pmax measured at 25 °C. Errors included Pressure Non Linearity, Pressure Hysteresis and Repeatability.
3. Maximum deviation from the Ideal Transfer Function expressed as a percentage of the %FSS over the compensated temperature range. Includes calibration errors (Offset & Span), temperature errors (Offset & Span), pressure non-linearity, pressure and thermal hysteresis. TEB Errors for mBar Ranges below
4. The time for the output DAC to be updated with new data.
5. The time for the output DAC to have valid data after a power on reset.
6. Compensated and operating temperature for mBar ranges are 0 °C to 60 °C and -20 °C – to 105 °C, respectively.
7. Maximum pressure the sensor package can withstand without rupture.
8. Maximum pressure without degrading sensor’s performance specifications.
9. Maximum pressure the silicon diaphragm can withstand without rupture.
10. Exceeding Absolute Maximum Specification may damage the device. Extended exposure beyond the operating conditions may affect device reliability.

PRESSURE AND TEMPERATURE TRANSFER FUNCTIONS

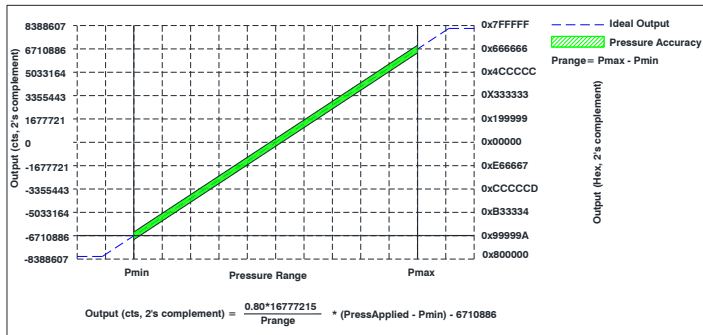

Type 1, 10-90%, Pressure Transfer Function

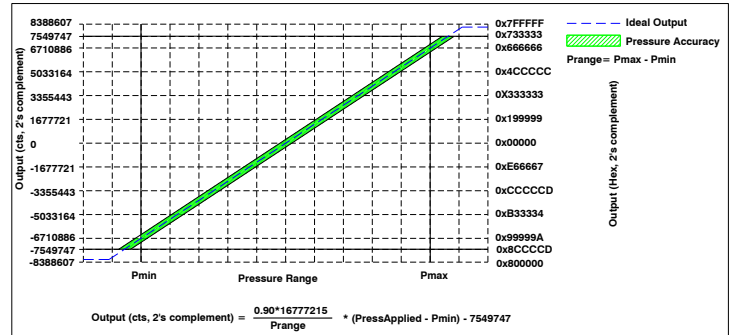

Type 2, 5-95%, Pressure Transfer Function

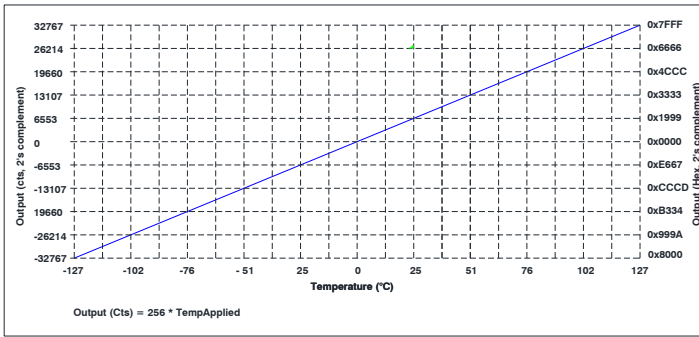

Temperature Transfer Function

MECHANICAL DIMENSIONS in [mm]

DUAL IN LINE, THRU HOLE

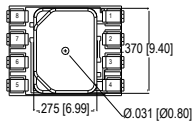
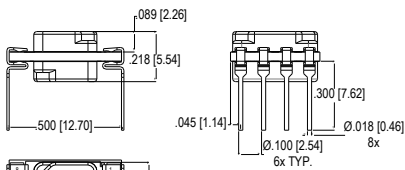
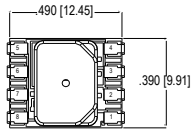

VERTICAL HOLE, DUAL

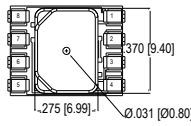
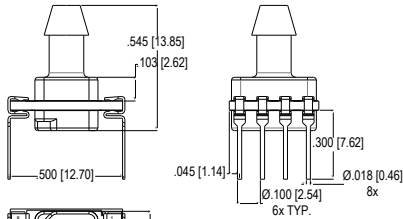
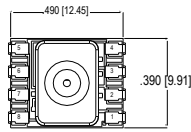

VERTICAL BARB, TOP

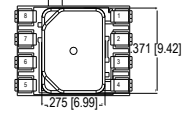
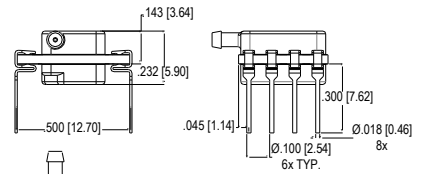
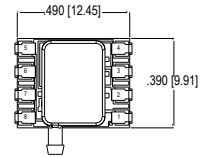

HORIZONTAL BARB, TOP

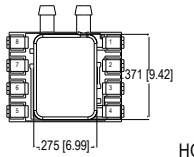
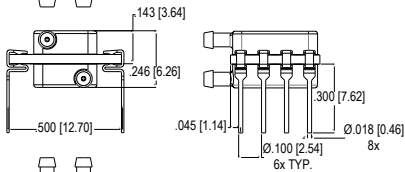
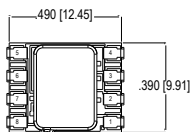

HORIZONTAL BARB, DUAL

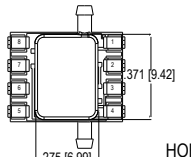
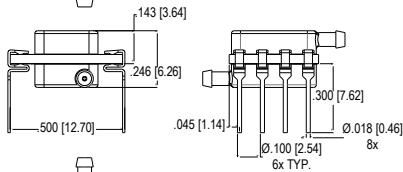
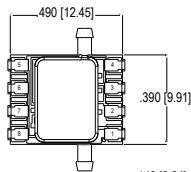

HORIZONTAL BARB, OPOSING

DUAL IN LINE, J LEAD SMT

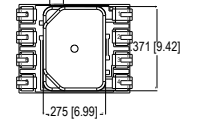
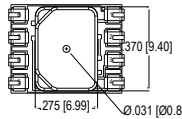
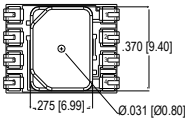
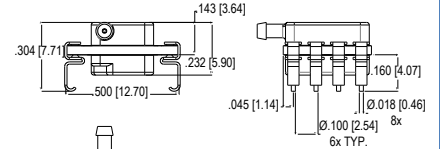
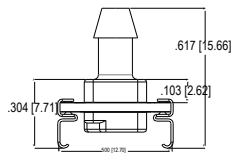
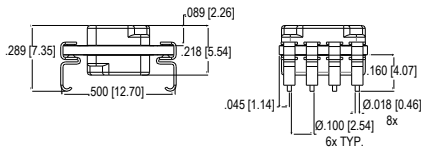
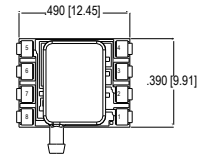
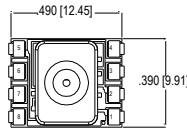
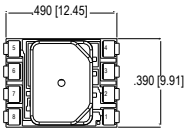

VERTICAL HOLE, DUAL

VERTICAL BARB, TOP

HORIZONTAL BARB, TOP

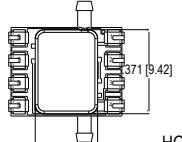
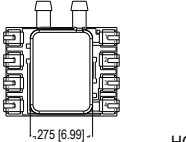
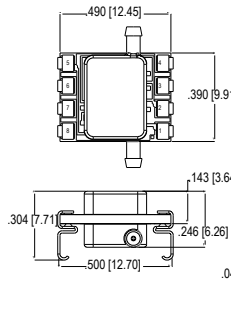
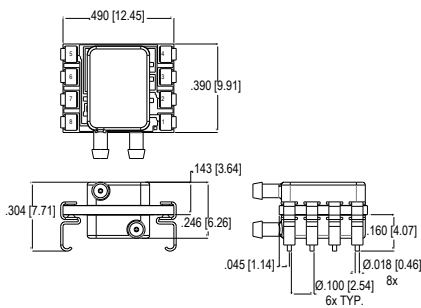

HORIZONTAL BARB, DUAL

HORIZONTAL BARB, OPOSING

PART NUMBERING FOR ORDERS

Series	Port Type	Package Style	Pressure Range	Pressure Units	Pressure Type (Range Availability) [Package Availability]	Calibrated Voltage	Output Type	Digital Protocol
MCT-24DHRD	VHD=Vertical Hole, Dual	J= J lead SMT	005	M=mBar	G= Gage (All Ranges) [All Port Types] A=Absolute (15 - 150PSI) [All Port Types] B=Bidirectional (All Ranges) [All Port Types]	3=3.3Vdc	Type1= 10 -90% of Supply Voltage	I1=I2C, 0x28H I2=I2C, 0x38H I3=I2C, 0x48H [All Packages] S1=SPI [All Packages]
			010					
			020					
	HBD=Horizontal Barb, Dual	T= DIL Thru Hole	050					
			100					
			200					
	VBT=Vertical Barb, Top	S=SIL	001	P=PSI				
			002					
			005					
	HBO=Horizontal Barb, Opposing		015					
			030					
			050					
HBT=Horizontal Barb, Top		100						
		150						
		001		B=Bar				
002								
003								
006								

Part Number Example: MCT-24DHRD VBTJ005PB31S1 Vertical Barbed Top Port, J Leaded SMT Package, -5 to +5 PSI Range, 3.3Vdc Supply, SPI Protocol, Pmin=-5, Pmax=+ 5 PSI

WARRANTY

Pressure sensors have a limited one-year warranty to the original purchaser. AVSensors will repair or replace, at its option, without charge those items it finds defective. This is the buyers sole remedy and is in lieu of all other warranties, expressed or implied, including those of merchantability and fitness for a particular purpose. In no event shall AVSensors be liable for consequential, special, or indirect damages. This warranty does not apply to units that have been modified, misused, neglected or installed where the application exceeds published ratings. Specifications may change without notice. The information supplied is believed to be accurate and reliable as of this printing, however, we assume no responsibility for its use.